

CASCOS

LIFTING PROFESSIONALS



4 POST LIFTS



C442

Type	Ref.	Min	kg			
Alignment platform	13442	190 mm	4Tn	1000 Kg.	230-400V/3ph/50Hz/3kW 230V/1ph/50Hz/2,2kW	35"

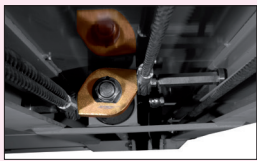
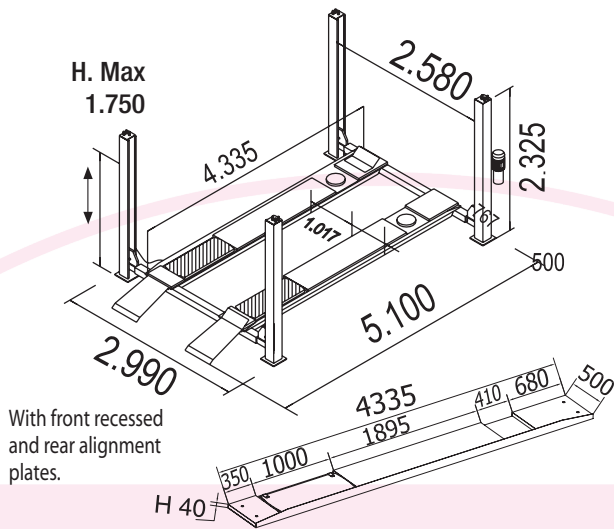

Security indicator

Indicator that prevents a bad levelling, and ensures that the cylinder works within the best conditions assuring a **longer lasting life**.



Hydraulic cylinders produced and tested one by one in our factory. The cylinders count with the **security valves that detects any lack of oil**, closing the circuit and preventing the lift from the descending.

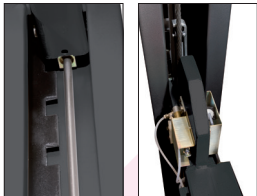

Security x2

Double security system in each post :

- **Mechanical** (safety bars)
- **Pneumatic** (security ladders)

Ensures a better reliability than the electromagnetic security system.

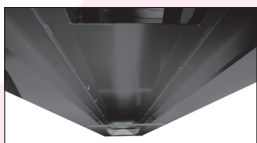

Our platforms are built with:

Reinforced super structure by double T steel beams for intensive use, keeping the platform flat/straight over the years.

Minimal height

Our platforms descend almost to the ground level avoiding the use of bulky run-up ramps to allow sport cars to go in (and consequently, using less garage area).



The lowest on the market!

H. Min. 190 mm

Alignment

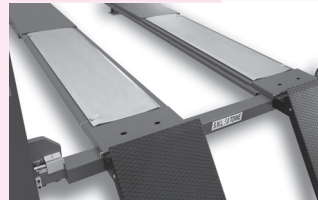

Alignment plates with the new **sliding bearings system**:

- More comfortable and sensitive to alignment.
- Manual lock in the center of the platform.

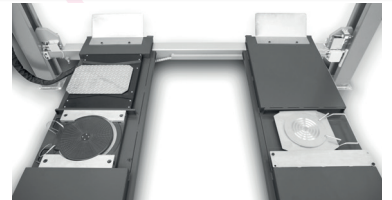

Recesses ready for alignment plates and / or turning plates 50 mm height. The lift includes **Steel spacers** for smaller turning plates.



Picture model C 442 (alignment)

VERSIONS WITH PLAY DETECTOR INTEGRATED

Lift includes play detector listed on VOSA accepted equipment, securely integrated on the platform designed with recesses to integrate turning plates and fix them in line with VOSA requirements.

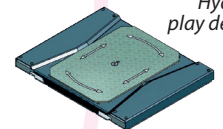

Hydraulic play detector

Repairable during at least 10 years.

We ensure spare parts availability during at least this period.



2006/42/CE & EN - 1493:2011
European Directives
& Approved Standards



Ref. 13442

4 POST LIFTS C442

OPTIONAL EQUIPMENT

Pneumatic Jacks

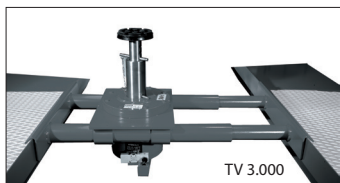

TV 3000

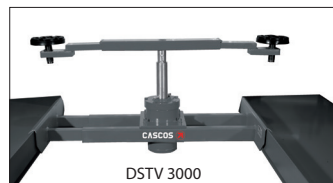

DSTV 3000

Double bracket

Mod.	TV 3000	DSTV 3000	DSTV 3000 AUDI
Ref.:	60.300	75.300	75.314
 kg	3.000	3.000	3.000

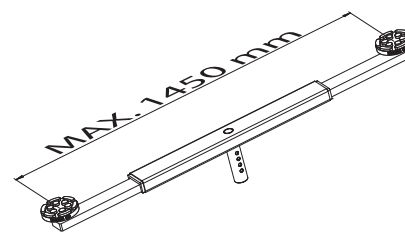
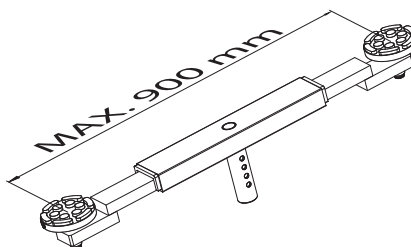
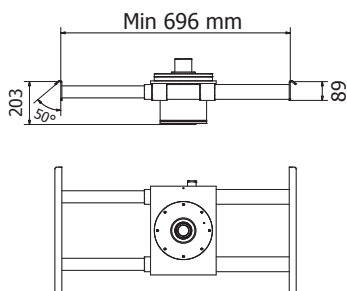

Oleopneumatic Jacks



4 Tn

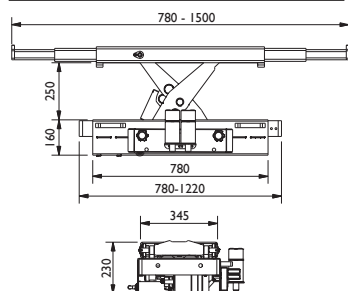

2 - 2,6 Tn

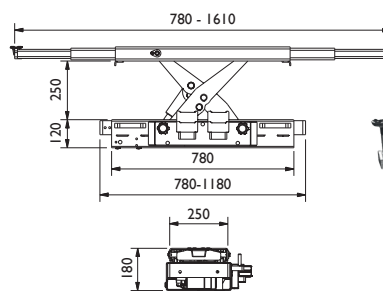

Capacity	Without lip		With lip	
	Ref	Ref	Ref	Ref
2 Tn	50515		50514	
2,6 Tn	50517		50516	
4 Tn	50565		50552	

Accesories

Magnetic lighting kit



LED 24 V
Without
installation

Ref.:
34053

Top Covers



Ref.:
32129

Magnetic holder for tools



Ref.:
26141

Additional buttoning column opposite



Ref.:
32160
32170

Magnetic air Kit



Ref.:
26177

Integrated power plug Assembled in factory



Ref.:
22164

www.cascos.es



CASCOS 

CASCOS MAQUINARIA, S.A.

Zurrupitieta, 8 - Pol. Ind. Júndiz • Apartado 264
01015 VITORIA-GASTEIZ / España/Spain
Tel. +34 945 290 294 / Fax +34 945 290 055
e-mail: info@cascos.es