

# SOLLEVATORI OLEOPNEUMATICI

## AIR HYDRAULIC JACKS

**215/N**  
**217/N**  
**221/N**



Sollevatore Oleopneumatico per mezzi pesanti, pratico e maneggevole. Rientro automatico dei pistoni; le due valvole di discesa garantiscono una tenuta perfetta in ogni situazione e una velocità controllata sotto carico. Ideale per officine, officine mobili, gommisti e carrozzerie.



*Air hydraulic jack for heavy vehicles, practical and easy to handle. The pistons move back automatically; the two descent valves guarantee perfect holding in all situations and controlled speed under load. Ideal for workshops, mobile workshops, tyre repairers and bodywork shops.*

	YAK 215/N	YAK 217/N	YAK 221/N
Portata Capacity	40/20 t 44/22 ton	40/20 t 44/22 ton	40/20 t 44/22 ton
Peso netto Net weight	39 kg 86 lb	41 kg 90 lb	46 kg 101 lb
Pressione di alimentazione Working air pressure	8-10 bar 116-145 psi	8-10 bar 116-145 psi	8-10 bar 116-145 psi
Consumo d'aria Air waste	400 nl/min	400 nl/min	400 nl/min



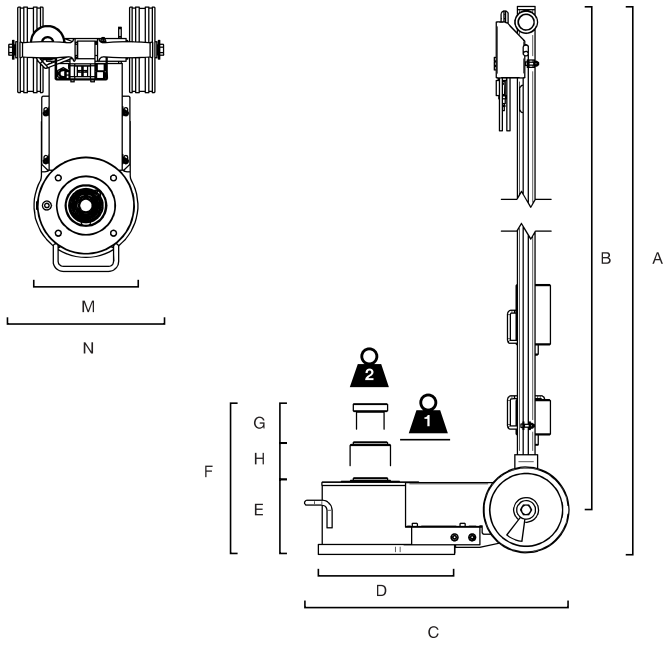





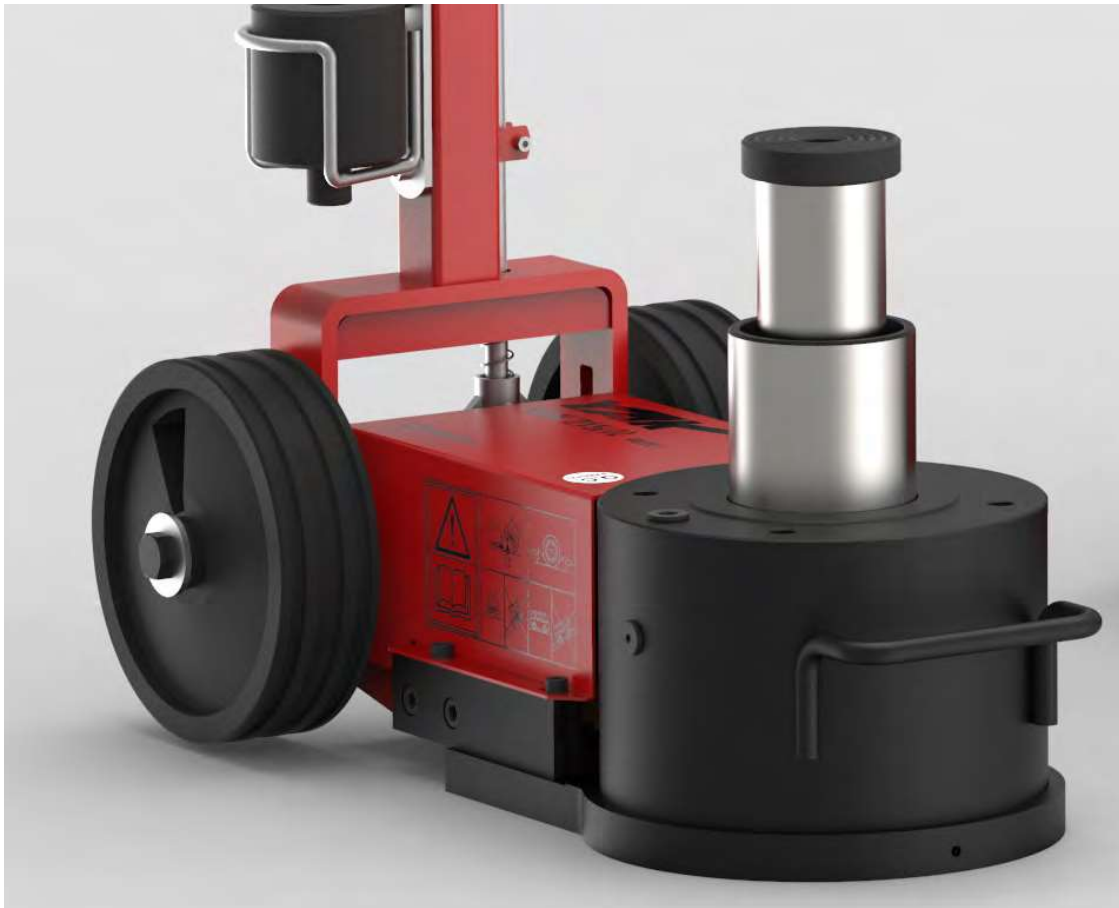





### ACCESSORI INCLUSI INCLUDED ACCESSORIES





	YAK 215/N	YAK 217/N	YAK 221/N
A	1400 mm 55.12 in	1400 mm 55.12 in	1400 mm 55.12 in
B	1311 mm 56.61 in	1311 mm 56.61 in	1311 mm 56.61 in
C	525 mm 20.67 in	525 mm 20.67 in	525 mm 20.67 in
D	325 mm 12.80 in	325 mm 12.80 in	325 mm 12.80 in
E	152 mm 5.98 in	174 mm 6.69 in	219 mm 8.62 in
F	370 mm 14.7 in	440 mm 17.32 in	469 mm 18.46 in
G	71 mm 2.80 in	89 mm 3.50 in	125 mm 4.92 in
H	147 mm 5.79 in	177 mm 6.97 in	250 mm 9.84 in
M	206 mm 8.11 in	206 mm 8.11 in	206 mm 8.11 in
N	310 mm 12.20 in	310 mm 12.20 in	310 mm 12.20 in
	20 t 22 ton	20 t 22 ton	20 t 22 ton
	40 t 44 ton	40 t 44 ton	40 t 44 ton



	YAK215/N	YAK217/N	YAK221/N
	•	•	•
	•	•	•
	•	•	•
	•	•	•
	•	•	•
	•	•	•
	•	•	•
	•	•	•
	•	•	•
	•	•	•
	•	•	•
	•	•	•
	•	•	•
	•	•	•