



Ravaglioli

COMPANY WITH
QUALITY SYSTEM
CERTIFIED BY DNV GL
= ISO 9001 =

SMONTAGOMME AUTOCARRO EXTRA RAPIDO 

SUPER FAST TRUCK TYRE CHANGER 

EXTRA SCHNELLE LKW MONTIERMASCHINE 

DEMONTE-PNEUS POIDS LOURDS SUPER RAPIDE 

DESMONTADORA PARA CAMIONES EXTRA RAPIDA 

GTB
16EVO



60
SINCE 1958



30 secondi: il tempo necessario per smontare e montare una comune ruota da camion.

30 seconds: the time you need to dismount and mount a common truck tyre.

30 sekunden: der notwendig Zeit um ein einfaches LKW Rad zu demontieren und montieren.

30 seconds: le temps nécessaire pour démonter et monter une roue commun de camion.

30 segundos: el tiempo necesario para desmontar y montar una ordinaria rueda de camion.

SUPER SPEED



Works in only 30% of the time needed by competition: a great energy-saver





Il GTB16EVO è unico nel suo genere. È provvisto di 4 rulli stallonatori con forma originale, posizionati ai 2 lati della ruota in punti diametralmente opposti. Con questo sistema, lo smontaggio del pneumatico con stallonatori è molto semplice e naturale: mentre gli stallonatori anteriori tengono il tallone al centro, i due posteriori continuano la loro corsa fino al completamento dello smontaggio.

The GTB16EVO is a one-of-a-kind. It is equipped with four rollers with a unique form, positioned on the two sides of the wheel in diametrically opposite positions. With this system, the dismantling of the tyre with bead breakers is very simple and natural: while the anterior bead breakers keep the bead in the drop centre, the posterior ones continue their course until the dismantling is complete.

GTB16EVO ist die einzige Reifenmontiermaschine dieser Art. Die Abdrückerrollen, die an genau entgegen gesetzten Stellen an den 2 Radseiten positioniert sind, besitzen ein originelles Design. Mit diesem System ist die Reifenmontage mit Abdrückem sehr einfach und natürlich: während die vorderen Abdrücker den Wulst in der Mitte halten, gleiten die beiden hinteren Abdrücker weiter, bis der Reifen vollständig abgedrückt ist.

GTB16EVO est unique en son genre. La machine est dotée de 4 rouleaux décolle-talon de forme exclusive placés sur 2 côtés de la roue dans des positions diamétralement opposées. Grâce à ce système, le démontage du pneumatique à l'aide d'un décolle-talon est extrêmement simple et facile: tandis que les décolle-talon antérieurs maintiennent le talon au centre, les deux décolle-talon postérieurs exercent leur action jusqu'au démontage complet.

El GTB16EVO es único en su género. Está equipado con 4 rodillos destalonadores con forma original, colocados en los 2 lados de la rueda en puntos diametralmente opuestos. Con este sistema, el desmontaje del neumático con destalonadores es muy sencillo y natural: mientras que los destalonadores delanteros mantienen el talón en el centro, los dos traseros siguen su recorrido hasta completar el desmontaje.

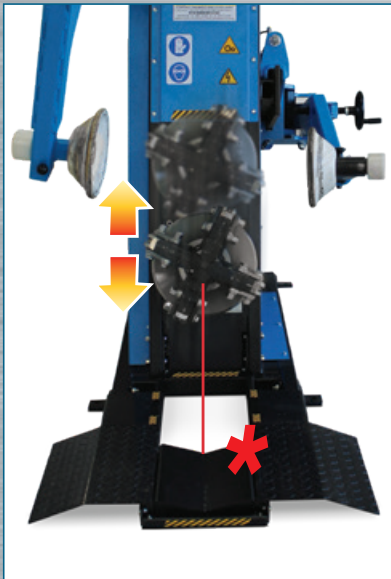

Il gruppo mandrino è in grado di muoversi sia in senso orario che antiorario, ma anche verso l'alto e il basso. Il dispositivo di bloccaggio è stato progettato per consentire l'aggrappamento di qualsiasi genere di ruota.

The chucking unit is able to move not only clockwise and counter-clockwise, but also up and down. The clamping device is designed to clamp all kind of wheels.

Die Spannvorrichtung kann sich sowohl in die Uhr-als auch Gegenuhzeigerichtung, und auch hoch und runter bewegen.

Le mandrin est en mesure de se déplacer aussi bien dans le sens des aiguilles d'une montre que dans le sens inverse, mais également vers le haut et vers le bas.

El plato puede moverse tanto hacia la derecha como hacia la izquierda, pero también hacia arriba y hacia abajo.

Hydraulic Up-Down Movement

- * MINIMUM HEIGHT
340 mm (13,5")
- MINIMUM CLAMPING
Ø 90 mm (3,5")

STAND BY

Grazie alla funzione "STAND-BY" abbiamo completamente eliminato il rumore che tutte le macchine fanno comunque quando non sono in funzione.

Thanks to the "STAND-BY" function, we totally eliminate the noise when the machine is not working.

Dank zu der "STAND-BY" Funktion, wir haben das Geräusch ganz beseitigt, wenn die Maschine nicht arbeitet.

Grâce a la fonction "STAND-BY" nous avons complètement éliminé le rumeur qui font le machines quand ne travaillent pas.

Gracias a la función de "STAND-BY" hemos eliminado el ruido que todas las maquinas cuando no trabajan.

QUICK SETUP FRONT ROLLER



Gli stallonatori sono di materiale sintetico per evitare danni al cerchio.

The bead breakers are made in plastic material to prevent damage to the rim.

Abdrücker sind aus Kunststoff und schützen Alu-Felgen vor Kratzer

Les détalonneurs sont en matériel synthétique afin d'éviter d'endommager la jante.

Los destalonadores son de material sintético para no dañar la llanta.

QUICK SETUP REAR ROLLER

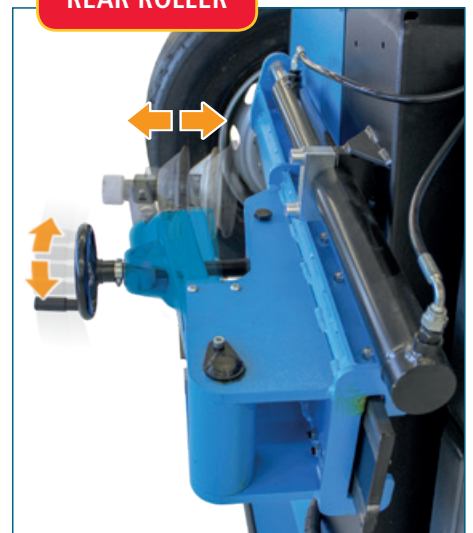

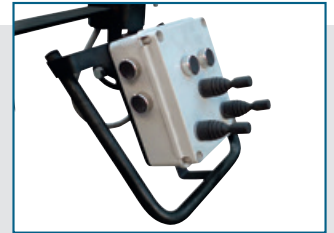
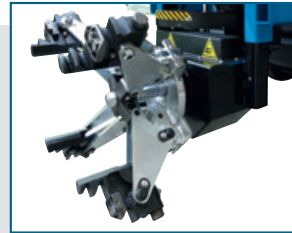

Mandrin idraulico. Adatto anche per ruote agricoltura (+G108A24).

Hydraulic chucking table. Suitable also for agricultural tyres (+G108A24).

Hydraulische Spannvorrichtung. Geeignet auch für Landwirtschaftsräder (+G108A24).

Mandrin hydraulique. Apte aussi au pneus agricoles (+G108A24).

Plato mandril hidráulico. Puede ser utilizada con ruedas agrícolas también (+G108A24).

Tutti i movimenti idraulici sono controllati da una console posizionata ergonomicamente.

All movements are hydraulically controlled from a convenient, ergonomically positioned console.

Alle hydraulischen Bewegungen werden von einem ergonomisch positionierten Bedienpult gesteuert.

Tous les mouvements hydrauliques sont contrôlés par une console placée dans une position ergonomique.

Todos los movimientos hidráulicos se controlan desde una consola colocada de forma ergonómica.

SPEED MOUNTING

La macchina è fornita di una leva brevettata che facilita il montaggio/smontaggio del pneumatico.

The machine is equipped with a patented lever to ease the mounting/demounting of the tyre.

Die Maschine ist mit einem patentierten Montagehebel ausgestattet, um die Montage/Demontage zu erleichtern.

La machine est équipée d'un levier breveté qui facilite le montage et le démontage de la roue.

La máquina está equipada con una palanca patentada Butler que facilita el montaje/desmontaje de la rueda.

STANDARD

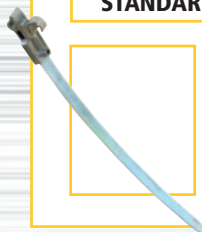

G108A3
 Leva brevettata.
 Patented lever.
 Patentiertes Montiereisen.
 Levier breveté.
 Palanca patentada.



11" - 27"

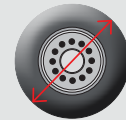

1320 mm (52")



540 mm (21")

SPEED DEMOUNTING



Gli stallonatori sono supportati da due bracci comandati separatamente. Ogni braccio ha due rulli stallonatori, uno conico che spinge sul tallone, e uno cilindrico che spinge la spalla del pneumatico.

The bead breakers are supported by two arms separately commanded. Each arm has two rollers, one conical which pushes on the bead and one cylindrical which pushes the side of the tyre.

Die Abdrückrollen sind mit zwei separat Abdrückarmen gesteuert. Auf jedem Arm befinden sich zwei Abdrückrollen: ein konischer Abdrücker drückt auf den Wulst und ein zylindrischer Abdrücker drückt auf die Reifenschulter.

Les décolle-talon sont soutenus par deux bras commandés séparément. Chaque bras dispose de deux rouleaux décolle-talon, l'un conique qui pousse le talon, l'autre cylindrique qui pousse le pil du pneumatique.

Los destalonadores se apoyan en dos brazos accionados por separado. Cada brazo tiene dos rodillos destalonadores (en teflon, para no dañar la llanta), uno cónico que empuja el talón, y otro cilíndrico que empuja el flanco del neumático.



STANDARD + SUPER-SINGLE

Le dimensioni del mandrin e le corse di lavoro del carrello stallonatore consentono di operare su tutta la gamma di ruote, incluso il tipo super-single.

The operating dimensions of the rim clamping unit and of the head-tool carriage allow the tyre changer to operate on a whole range of wheels, including super-single.

Die Größe der Spannvorrichtung und der Arbeitsbereich des Schlittens ermöglichen den Einsatz auf allen Radtypen, auch auf den "Super-Single" Reifen.

Les dimensions du mandrin et les courses d'exercice du bras de détalonnage permettent d'opérer sur toute la gamme de roues, y comprises les roues type "super-single"

Las dimensiones del plato y las corridas de trabajo del carro destalonador permiten de trabajar una gama amplísima de ruedas, el tipo super-single incluido.



**COMPACT
DESIGN**

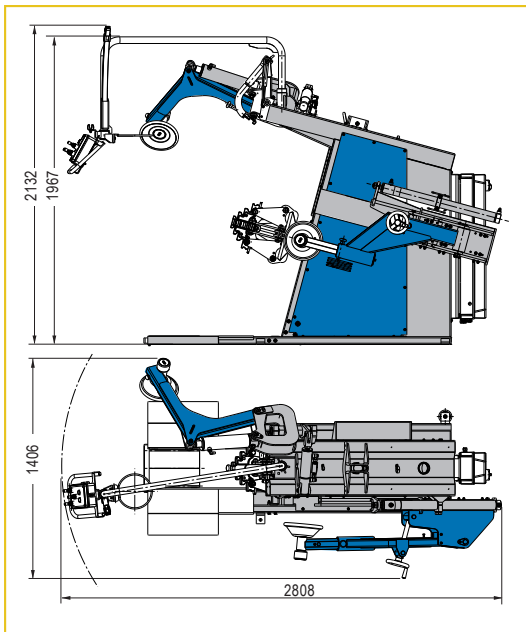

OPTION



G108A42
Tool extension lever



G108A40
Bloccaggio albero
Shaft position lock



G108A2
Alu rim clamp
(4 x kit)



G90A6
Alu rim clamp



G108A24
Disc for wheels
with lock ring



G108A9
Protezione utensile in materiale
sintetico.
Plastic tool protection.
Kunststoffkopfschutz.
Protection synthétique de l'outil.
Protección util en material sintético.

SPECIAL VERSION



VARGNAV101ND
3 velocità (1-5-10 rpm)
3 speed (1-5-10 tpm)

DATI TECNICI	TECHNICAL DATA	TECHNISCHE DATEN	DONNEES TECHNIQUES	DATOS TÉCNICOS	GTB16EVO
Motore rotazione mandrino	Chucking unit rotation motor	Motor für Drehung der Spannvorrichtung	Moteur rotation mandrin	Motor rotación plato	2 kW
Motore centralina	Hydraulic drive unit motor	Hydraulikmotor	Moteur de la pompe	Motor unidad hidráulica	1,5 kW
Ø cerchi	Rim Ø	Felgen-Ø	Ø de la jante	Ø de llantas	11" - 27"
Ø est. ruota ammesso	Max. wheel Ø	Raddurchmesser	Ø de la roue	Ø maximo ext. rueda	1320 mm (52")
Larghezza max. ruota	Max. allowed wheel width	Max. Radbreite	Largeur maxi de la roue	Ancho max. rueda	540 mm (21.2")
Peso	Weight	Gewicht	Poids	Peso	650 kg
Potenza stallonatore	Bead breaker power	Abdrückerkraft	Force du détalonneur	Force du détalonneur	18000 N
Peso max ruota	Max wheel weight	Maximales Radgewicht	Poids maxi de la roue	Poids maxi de la roue	1200 kg/2645 lbs
Velocità di rotazione mandrino (giri/min)	Chuck rotation speed (rev./min)	Sperrvorrichtung-Drehgeschwindigkeit (U./min.)	Vitesse de rotation du mandrin (tours/min.)	Velocidad de rotación mandril (rev./min.)	8
Coppia max al mandrino	Max. torque to chuck	Max. Sperrvorrichtung-Drehmoment	Couple max. au mandrin	Par máx al mandril	2600 Nm

Ravaglioli

Ravaglioli S.p.A.

via 1° maggio 3
Fraz. Pontecchio M.
40037 Sasso Marconi (Bo) - Italia
Tel. +39 - 051 - 6781511
Fax +39 - 051 - 846349
rav@ravaglioli.com
www.ravaglioli.com

RAV France

4, Rue Longue Raie
ZAC de la Tremblaie
91220 Le Plessis Pâté
Tel. 01.60.86.88.16
Fax 01.60.86.82.04
rav@ravfrance.fr

Ravaglioli Deutschland

Kirchenpoint 22
85354 Freising
Tel. 08165-646956
Fax 08165-646958
ravd@ravaglioli.com

RAV Equipment UK LTD

Prince Albert House
20 King Street
Maidenhead, SL6 1DT
Tel. +39 - 0516781511
rav@ravaglioli.com

RAV en Belgique

Nederlandstalig
Tel. 0498-162016
Fax 016-781025
Zone Francophone
Tel. 0498-163016
Fax +32 78 055 030

RAV Equipos España S.L.U.

Avenida Europa 17
Pol. Ind. de Constanti
Tarragona 43120
Tel. 977 524525
Fax 977 524532
ravequipos@ravaglioli.e.telefonica.net



A DOVER COMPANY

DRN15U (5)

Le caratteristiche tecniche e gli allestimenti presentati in questo prospetto possono subire variazioni. Le immagini riprodotte non sono vincolanti.
Technical data and composition presented in this catalogue may vary. Pictures reproduced are only indicative.
Die techn. Daten und die Ausrüstungen, die in diesem Prospekt enthalten sind, können Änderungen erfahren. Deshalb sind die Abbildungen unverbindlich.
Les caractéristiques techniques et les compositions présentées dans ce prospectus peuvent subir des variations. Les images reproduites n'ont qu'une valeur indicative.
Las características técnicas y las composiciones ilustradas en este folleto pueden sufrir variaciones. Las imágenes propuestas son solamente indicativas.

